

BHP

Repurposing Flotation Capacity at Mt Keith Nickel Concentrator

Brent Sullivan

Kalgoorlie Met Fest 2017

Mt Keith Overview

- **Large, low grade, disseminated nickel sulphide ore body**
- **Northern Goldfields**
- **Commissioned in 1994 at 6.6 Mt/y**
- **2016 Production**
 - 10.5 Mt
 - Average head grade 0.54% Nickel
 - 35 000 Nickel tonnes



NMK Process

Module 1

Grinding

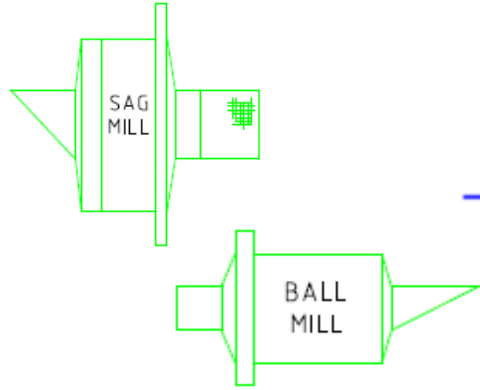

Classification

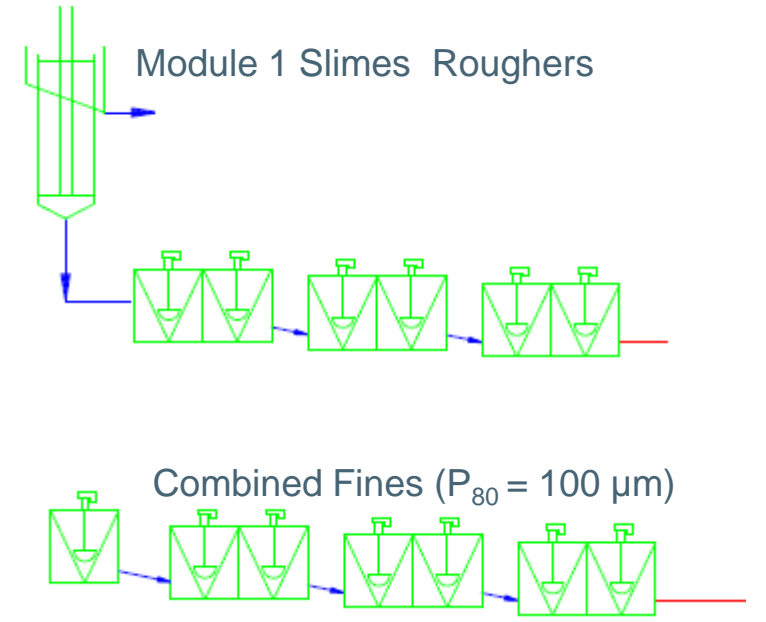
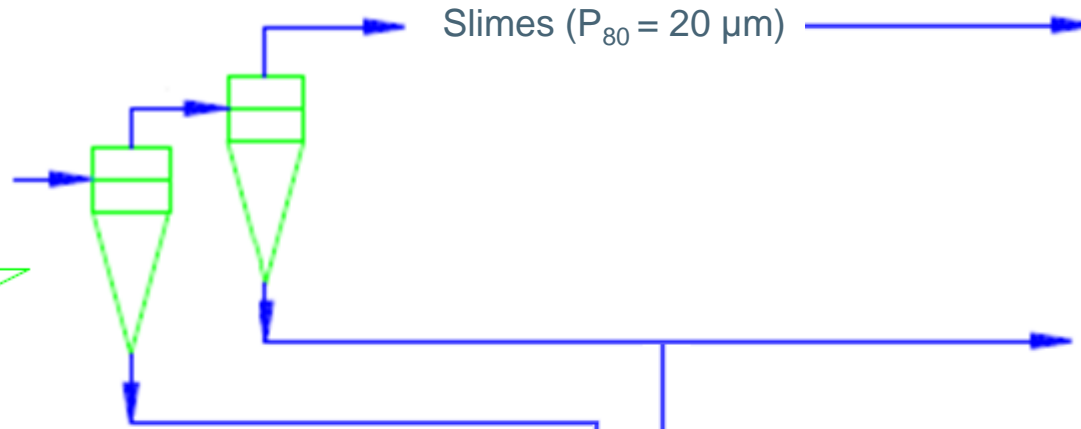

Module 2

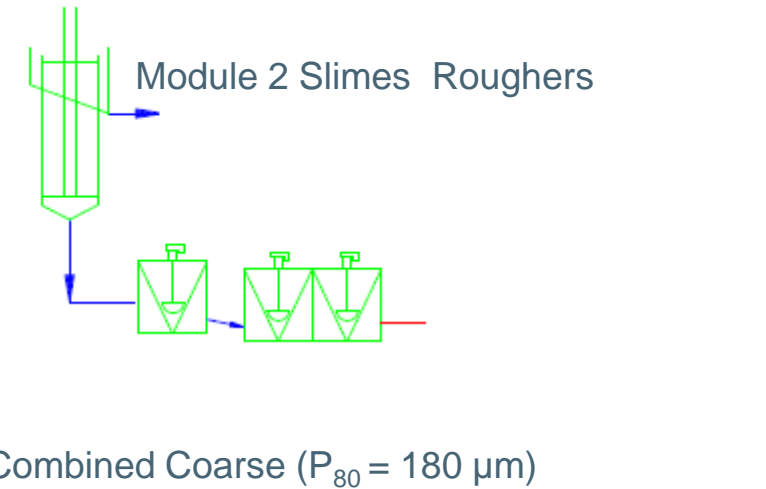
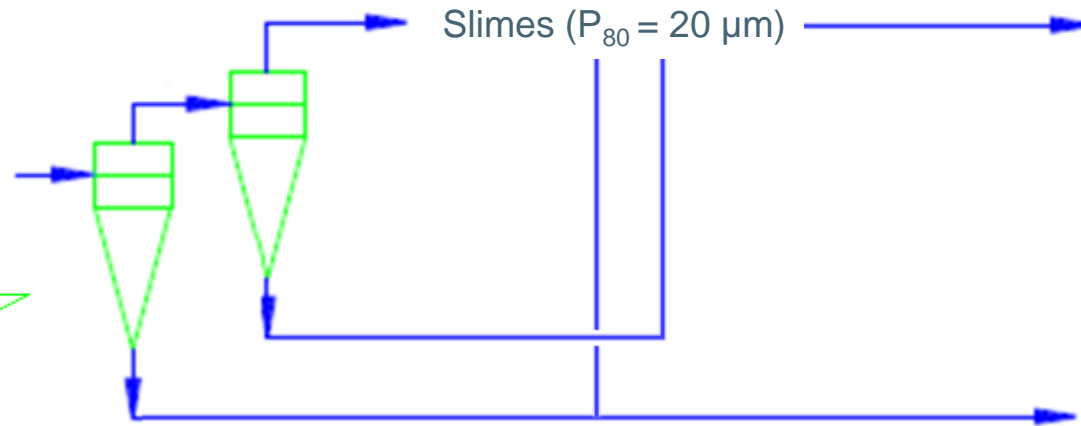
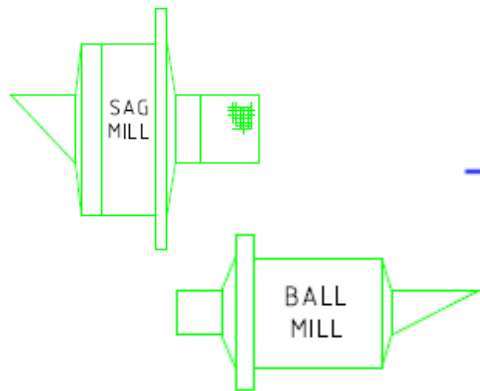

NMK Process – Flotation Continued

Module 1

Fines & Slimes
Rougher Concentrate

Rougher, Middlings, Scavengers

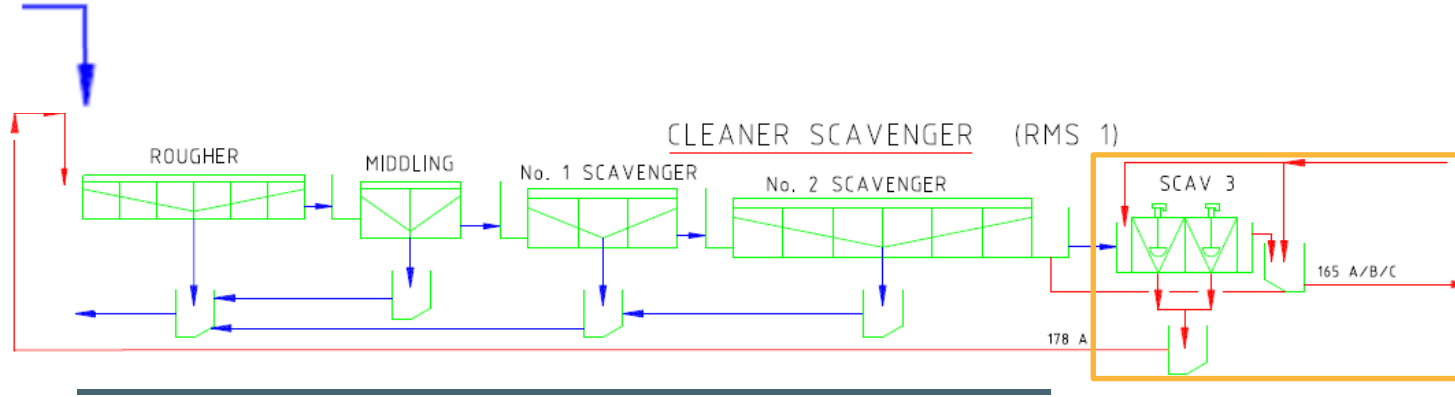

Cleaner Recleaners

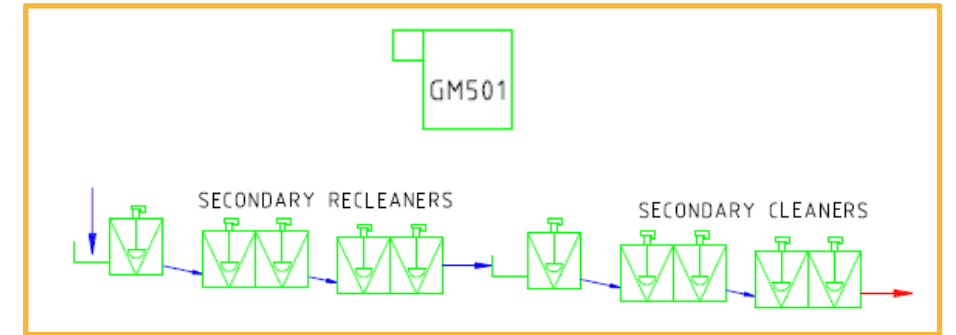

Module 2

Coarse Feed

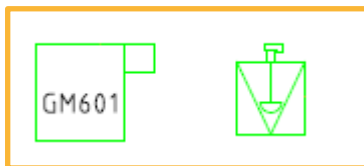
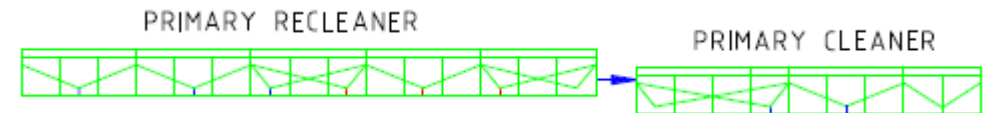
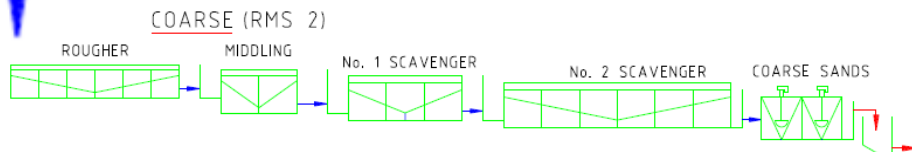

Talc Redesign Project

BHP

NMK Process – Flotation Continued

Module 1

Fines & Slimes
Rougher Concentrate

Rougher, Middlings, Scavengers

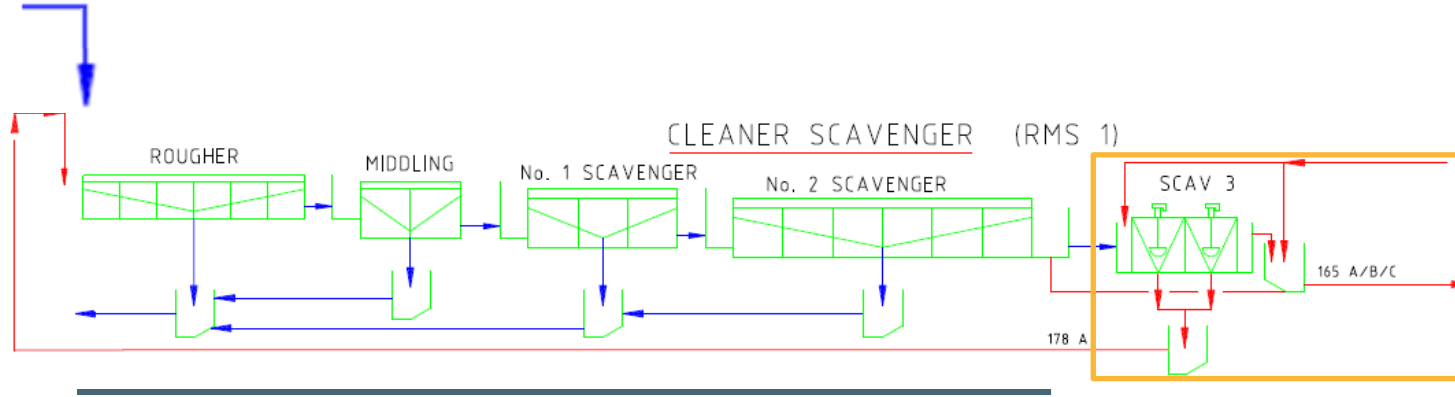

Cleaner Recleaners

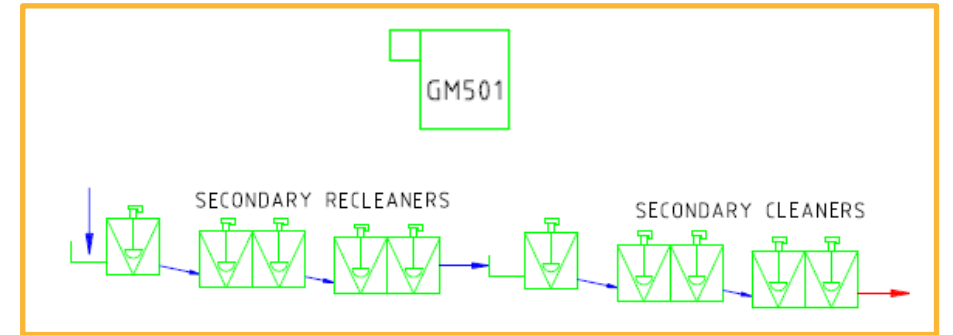

Module 2

Coarse Feed

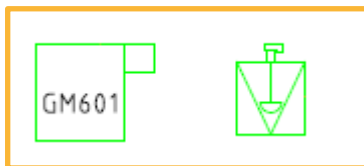
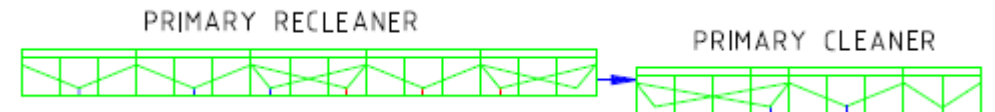
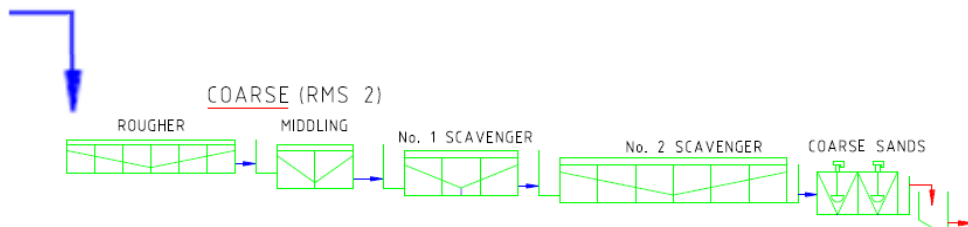

Talc Redesign Project

BHP

Opportunity Identified

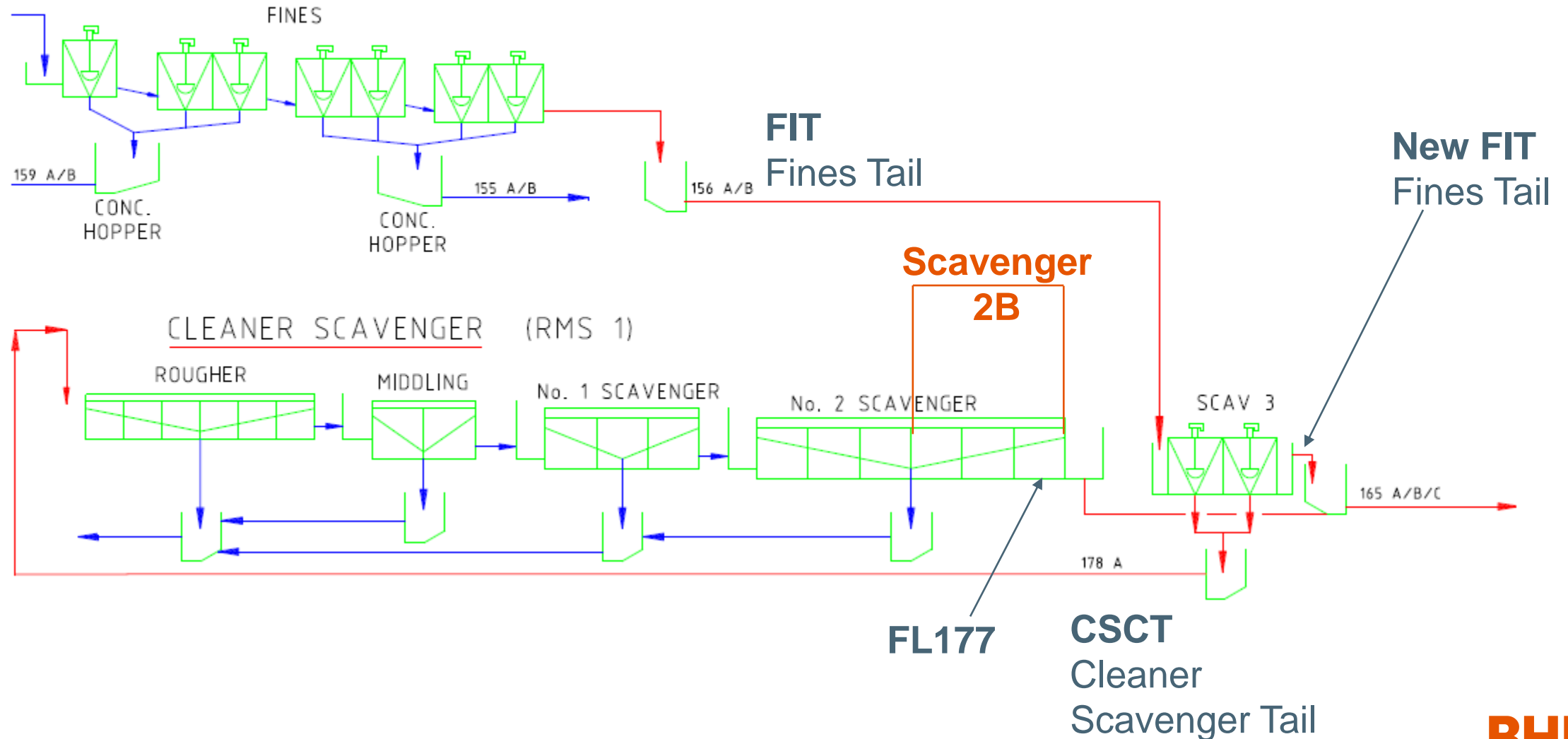

Opportunity Validated

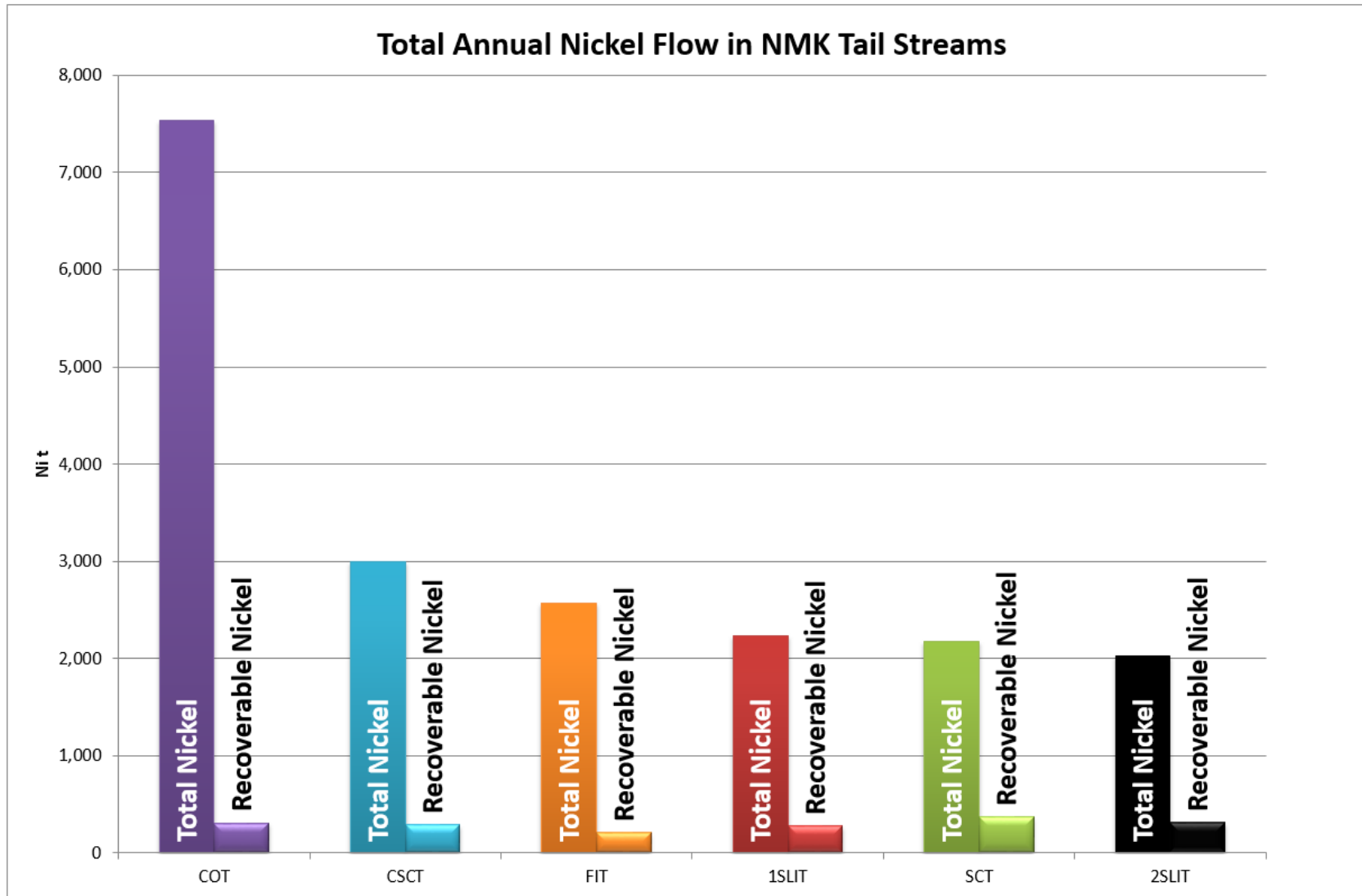

Costs vs Benefits

Benefits

- RMS1 gains 85 m³ of flotation capacity (FL177)
- Fines Rougher circuit gains 300 m³ of flotation capacity
- Upstream stability

Costs

- RMS1 loses 300 m³ of flotation capacity (Scav 3)
- Capital works

Birds Eye View

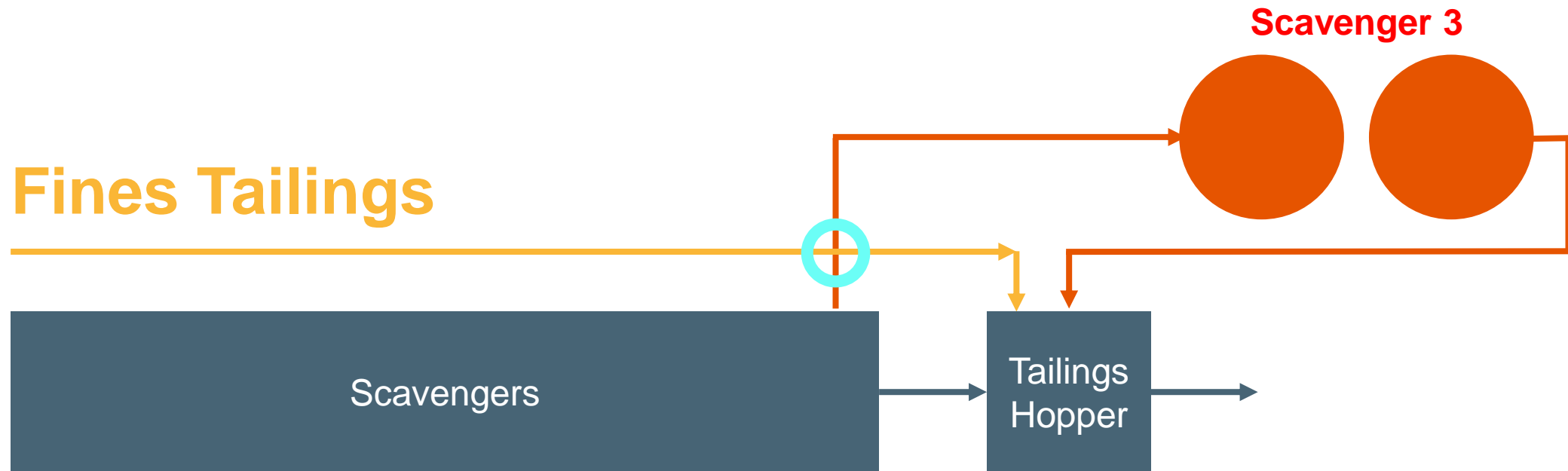

Project Capital Cost

- Pipe spools
- 2x valves
- Control station
- DCS integration
- \$220k total
- Retain ability to use Scav 3 in either FIT, CSCT duty or bypassed



Performance Improvement

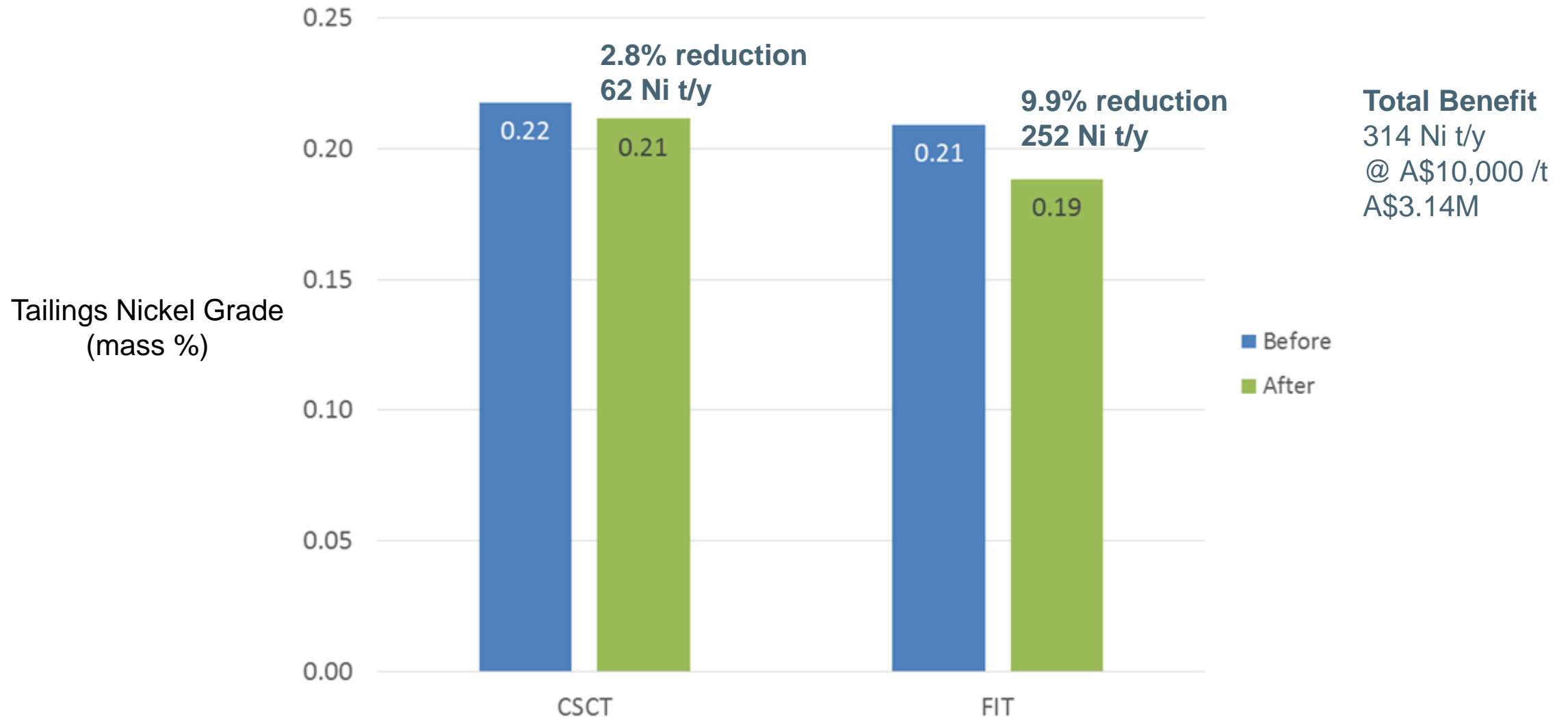

Key Learnings for Mt Keith Mets

- We have a lot of data, the challenge is how to make use of it.
- Never stop questioning your plant design.
- Stability has more of an impact than we thought.
- Ask your operators! They know the plant as well as anyone and will often be able to instantly point out problem areas.

BHP